



# wwPDB X-ray Structure Validation Summary Report ⓘ

Mar 5, 2026 – 08:38 PM UTC

PDB ID : 2HIM / pdb\_00002him  
Title : Crystal Structure and Allosteric Regulation of the Cytoplasmic Escherichia coli L-Asparaginase I  
Authors : Yun, M.K.; Nourse, A.; White, S.W.; Rock, C.O.; Heath, R.J.  
Deposited on : 2006-06-29  
Resolution : 1.82 Å(reported)

This is a wwPDB X-ray Structure Validation Summary Report for a publicly released PDB entry.

We welcome your comments at [validation@mail.wwpdb.org](mailto:validation@mail.wwpdb.org)

A user guide is available at

<https://www.wwpdb.org/validation/2017/XrayValidationReportHelp>

with specific help available everywhere you see the ⓘ symbol.

The types of validation reports are described at

<http://www.wwpdb.org/validation/2017/FAQs#types>.

---

The following versions of software and data (see [references ⓘ](#)) were used in the production of this report:

MolProbity : 4-5-2 with Phenix2.0  
Mogul : 2022.3.0, CSD as543be (2022)  
Xtriage (Phenix) : 2.0  
EDS : 3.0  
Percentile statistics : 20250101.v01 (using entries in the PDB archive January 1st 2025)  
CCP4 : 9.0.010 (Gargrove)  
Density-Fitness : 1.0.12  
Ideal geometry (proteins) : Engh & Huber (2001)  
Ideal geometry (DNA, RNA) : Parkinson et al. (1996)  
Validation Pipeline (wwPDB-VP) : 2.49

# 1 Overall quality at a glance

The following experimental techniques were used to determine the structure:

*X-RAY DIFFRACTION*

The reported resolution of this entry is 1.82 Å.

Percentile scores (ranging between 0-100) for global validation metrics of the entry are shown in the following graphic. The table shows the number of entries on which the scores are based.

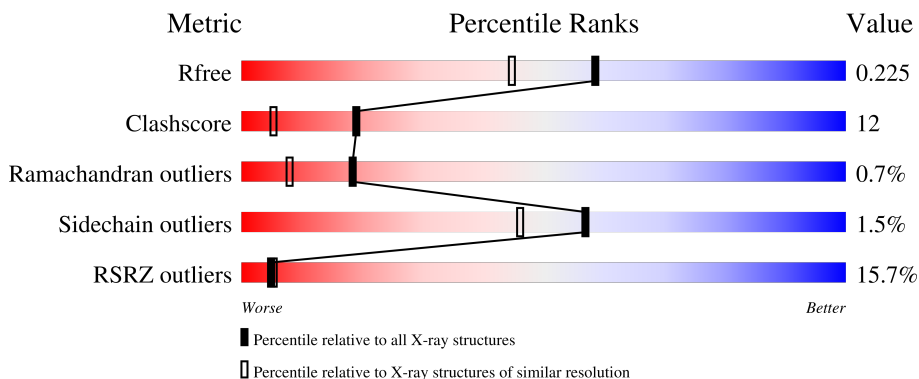

Metric	Whole archive (#Entries)	Similar resolution (#Entries, resolution range(Å))
$R_{free}$	180053	1112 (1.82-1.82)
Clashscore	190562	1148 (1.82-1.82)
Ramachandran outliers	187476	1140 (1.82-1.82)
Sidechain outliers	187428	1140 (1.82-1.82)
RSRZ outliers	180081	1112 (1.82-1.82)

The table below summarises the geometric issues observed across the polymeric chains and their fit to the electron density. The red, orange, yellow and green segments of the lower bar indicate the fraction of residues that contain outliers for  $\geq 3$ , 2, 1 and 0 types of geometric quality criteria respectively. A grey segment represents the fraction of residues that are not modelled. The numeric value for each fraction is indicated below the corresponding segment, with a dot representing fractions  $\leq 5\%$ . The upper red bar (where present) indicates the fraction of residues that have poor fit to the electron density. The numeric value is given above the bar.

Mol	Chain	Length	Quality of chain
1	A	358	
1	B	358	
1	C	358	
1	D	358	

## 2 Entry composition [i](#)

There are 5 unique types of molecules in this entry. The entry contains 10664 atoms, of which 0 are hydrogens and 0 are deuteriums.

In the tables below, the ZeroOcc column contains the number of atoms modelled with zero occupancy, the AltConf column contains the number of residues with at least one atom in alternate conformation and the Trace column contains the number of residues modelled with at most 2 atoms.

- Molecule 1 is a protein called L-asparaginase 1.

Mol	Chain	Residues	Atoms					ZeroOcc	AltConf	Trace
			Total	C	N	O	S			
1	A	324	2475	1569	426	468	12	0	0	0
1	B	329	2518	1595	435	476	12	0	0	0
1	C	324	2489	1579	428	470	12	0	0	0
1	D	331	2531	1603	438	478	12	0	0	0

There are 84 discrepancies between the modelled and reference sequences:

Chain	Residue	Modelled	Actual	Comment	Reference
A	-19	MET	-	cloning artifact	UNP P0A962
A	-18	GLY	-	cloning artifact	UNP P0A962
A	-17	SER	-	cloning artifact	UNP P0A962
A	-16	SER	-	cloning artifact	UNP P0A962
A	-15	HIS	-	expression tag	UNP P0A962
A	-14	HIS	-	expression tag	UNP P0A962
A	-13	HIS	-	expression tag	UNP P0A962
A	-12	HIS	-	expression tag	UNP P0A962
A	-11	HIS	-	expression tag	UNP P0A962
A	-10	HIS	-	expression tag	UNP P0A962
A	-9	SER	-	cloning artifact	UNP P0A962
A	-8	SER	-	cloning artifact	UNP P0A962
A	-7	GLY	-	cloning artifact	UNP P0A962
A	-6	LEU	-	cloning artifact	UNP P0A962
A	-5	VAL	-	cloning artifact	UNP P0A962
A	-4	PRO	-	cloning artifact	UNP P0A962
A	-3	ARG	-	cloning artifact	UNP P0A962
A	-2	GLY	-	cloning artifact	UNP P0A962
A	-1	SER	-	cloning artifact	UNP P0A962
A	0	HIS	-	cloning artifact	UNP P0A962
A	162	ALA	THR	engineered mutation	UNP P0A962

*Continued on next page...*

*Continued from previous page...*

Chain	Residue	Modelled	Actual	Comment	Reference
B	-19	MET	-	cloning artifact	UNP P0A962
B	-18	GLY	-	cloning artifact	UNP P0A962
B	-17	SER	-	cloning artifact	UNP P0A962
B	-16	SER	-	cloning artifact	UNP P0A962
B	-15	HIS	-	expression tag	UNP P0A962
B	-14	HIS	-	expression tag	UNP P0A962
B	-13	HIS	-	expression tag	UNP P0A962
B	-12	HIS	-	expression tag	UNP P0A962
B	-11	HIS	-	expression tag	UNP P0A962
B	-10	HIS	-	expression tag	UNP P0A962
B	-9	SER	-	cloning artifact	UNP P0A962
B	-8	SER	-	cloning artifact	UNP P0A962
B	-7	GLY	-	cloning artifact	UNP P0A962
B	-6	LEU	-	cloning artifact	UNP P0A962
B	-5	VAL	-	cloning artifact	UNP P0A962
B	-4	PRO	-	cloning artifact	UNP P0A962
B	-3	ARG	-	cloning artifact	UNP P0A962
B	-2	GLY	-	cloning artifact	UNP P0A962
B	-1	SER	-	cloning artifact	UNP P0A962
B	0	HIS	-	cloning artifact	UNP P0A962
B	162	ALA	THR	engineered mutation	UNP P0A962
C	-19	MET	-	cloning artifact	UNP P0A962
C	-18	GLY	-	cloning artifact	UNP P0A962
C	-17	SER	-	cloning artifact	UNP P0A962
C	-16	SER	-	cloning artifact	UNP P0A962
C	-15	HIS	-	expression tag	UNP P0A962
C	-14	HIS	-	expression tag	UNP P0A962
C	-13	HIS	-	expression tag	UNP P0A962
C	-12	HIS	-	expression tag	UNP P0A962
C	-11	HIS	-	expression tag	UNP P0A962
C	-10	HIS	-	expression tag	UNP P0A962
C	-9	SER	-	cloning artifact	UNP P0A962
C	-8	SER	-	cloning artifact	UNP P0A962
C	-7	GLY	-	cloning artifact	UNP P0A962
C	-6	LEU	-	cloning artifact	UNP P0A962
C	-5	VAL	-	cloning artifact	UNP P0A962
C	-4	PRO	-	cloning artifact	UNP P0A962
C	-3	ARG	-	cloning artifact	UNP P0A962
C	-2	GLY	-	cloning artifact	UNP P0A962
C	-1	SER	-	cloning artifact	UNP P0A962
C	0	HIS	-	cloning artifact	UNP P0A962
C	162	ALA	THR	engineered mutation	UNP P0A962

*Continued on next page...*

Continued from previous page...

Chain	Residue	Modelled	Actual	Comment	Reference
D	-19	MET	-	cloning artifact	UNP P0A962
D	-18	GLY	-	cloning artifact	UNP P0A962
D	-17	SER	-	cloning artifact	UNP P0A962
D	-16	SER	-	cloning artifact	UNP P0A962
D	-15	HIS	-	expression tag	UNP P0A962
D	-14	HIS	-	expression tag	UNP P0A962
D	-13	HIS	-	expression tag	UNP P0A962
D	-12	HIS	-	expression tag	UNP P0A962
D	-11	HIS	-	expression tag	UNP P0A962
D	-10	HIS	-	expression tag	UNP P0A962
D	-9	SER	-	cloning artifact	UNP P0A962
D	-8	SER	-	cloning artifact	UNP P0A962
D	-7	GLY	-	cloning artifact	UNP P0A962
D	-6	LEU	-	cloning artifact	UNP P0A962
D	-5	VAL	-	cloning artifact	UNP P0A962
D	-4	PRO	-	cloning artifact	UNP P0A962
D	-3	ARG	-	cloning artifact	UNP P0A962
D	-2	GLY	-	cloning artifact	UNP P0A962
D	-1	SER	-	cloning artifact	UNP P0A962
D	0	HIS	-	cloning artifact	UNP P0A962
D	162	ALA	THR	engineered mutation	UNP P0A962

- Molecule 2 is ASPARTIC ACID (CCD ID: ASP) (formula: C<sub>4</sub>H<sub>7</sub>NO<sub>4</sub>).

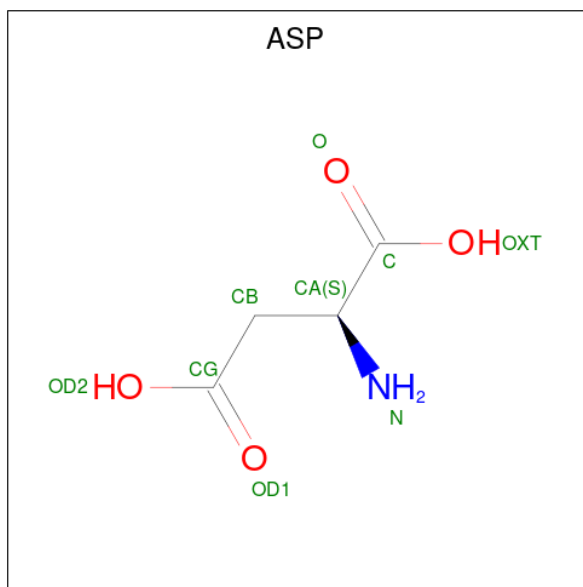

Mol	Chain	Residues	Atoms			ZeroOcc	AltConf	
			Total	C	N			O
2	A	1	8	4	1	3	0	1

Continued on next page...

Continued from previous page...

Mol	Chain	Residues	Atoms				ZeroOcc	AltConf
2	B	1	Total	C	N	O	0	1
			8	4	1	3		
2	C	1	Total	C	N	O	0	1
			8	4	1	3		
2	D	1	Total	C	N	O	0	1
			8	4	1	3		

- Molecule 3 is ASPARAGINE (CCD ID: ASN) (formula:  $C_4H_8N_2O_3$ ).

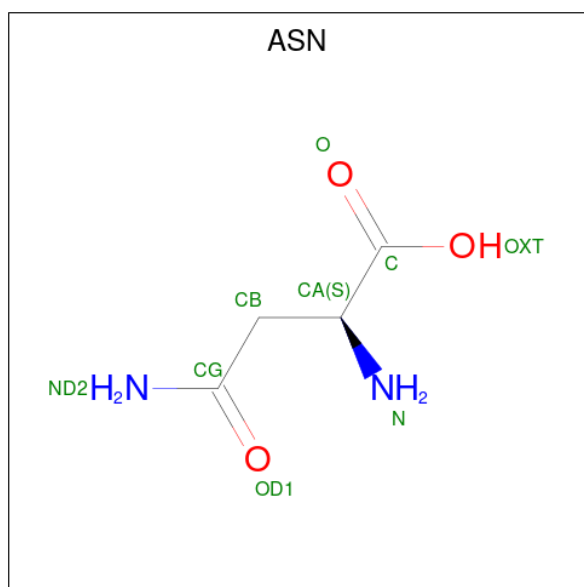

Mol	Chain	Residues	Atoms				ZeroOcc	AltConf
3	A	1	Total	C	N	O	0	0
			9	4	2	3		
3	A	1	Total	C	N	O	0	1
			9	4	2	3		
3	B	1	Total	C	N	O	0	0
			9	4	2	3		
3	B	1	Total	C	N	O	0	1
			9	4	2	3		
3	C	1	Total	C	N	O	0	0
			9	4	2	3		
3	C	1	Total	C	N	O	0	1
			9	4	2	3		
3	D	1	Total	C	N	O	0	0
			9	4	2	3		
3	D	1	Total	C	N	O	0	1
			9	4	2	3		

- Molecule 4 is 1,2-ETHANEDIOL (CCD ID: EDO) (formula:  $C_2H_6O_2$ ).

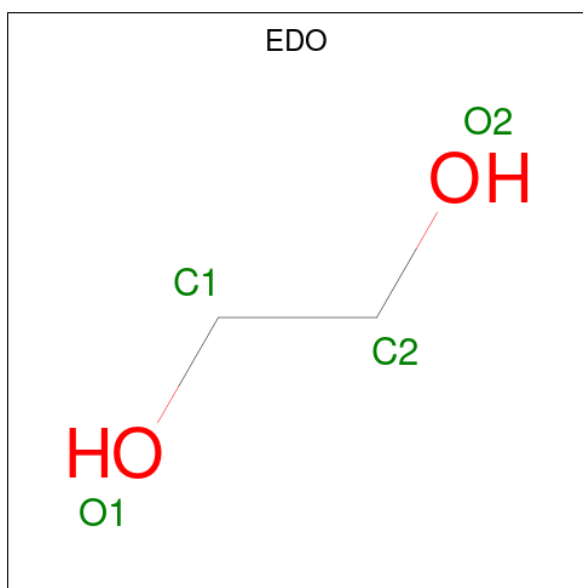

Mol	Chain	Residues	Atoms	ZeroOcc	AltConf
4	A	1	Total C O 4 2 2	0	0
4	A	1	Total C O 4 2 2	0	0
4	B	1	Total C O 4 2 2	0	0
4	B	1	Total C O 4 2 2	0	0
4	C	1	Total C O 4 2 2	0	0
4	C	1	Total C O 4 2 2	0	0
4	D	1	Total C O 4 2 2	0	0
4	D	1	Total C O 4 2 2	0	0

- Molecule 5 is water.

Mol	Chain	Residues	Atoms	ZeroOcc	AltConf
5	A	128	Total O 128 128	0	0
5	B	122	Total O 122 122	0	0
5	C	115	Total O 115 115	0	0

*Continued on next page...*

*Continued from previous page...*

<b>Mol</b>	<b>Chain</b>	<b>Residues</b>	<b>Atoms</b>		<b>ZeroOcc</b>	<b>AltConf</b>
5	D	150	Total 150	O 150	0	0

### 3 Residue-property plots [i](#)

These plots are drawn for all protein, RNA, DNA and oligosaccharide chains in the entry. The first graphic for a chain summarises the proportions of the various outlier classes displayed in the second graphic. The second graphic shows the sequence view annotated by issues in geometry and electron density. Residues are color-coded according to the number of geometric quality criteria for which they contain at least one outlier: green = 0, yellow = 1, orange = 2 and red = 3 or more. A red dot above a residue indicates a poor fit to the electron density ( $RSRZ > 2$ ). Stretches of 2 or more consecutive residues without any outlier are shown as a green connector. Residues present in the sample, but not in the model, are shown in grey.

- Molecule 1: L-asparaginase 1

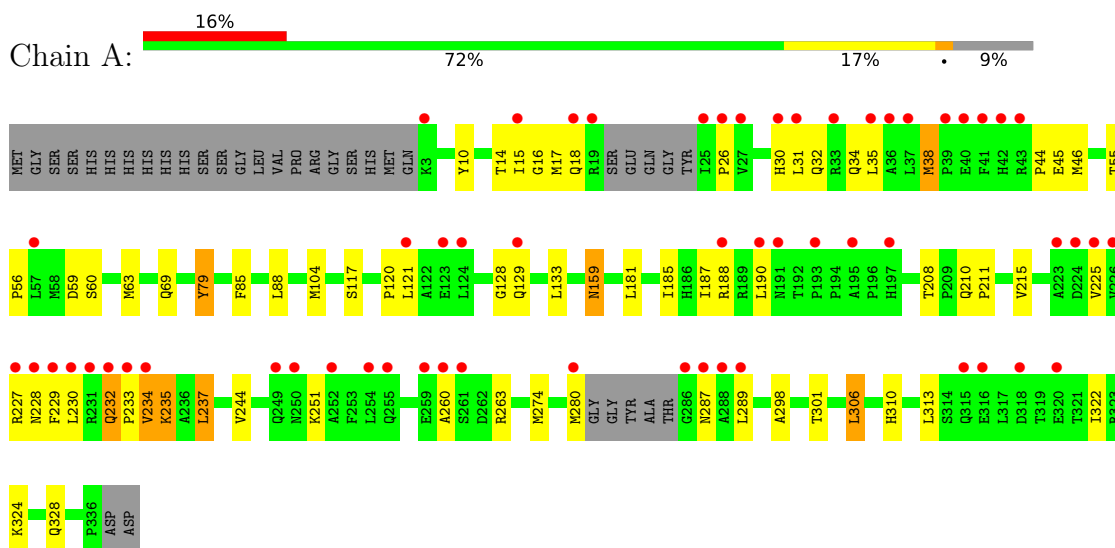

- Molecule 1: L-asparaginase 1

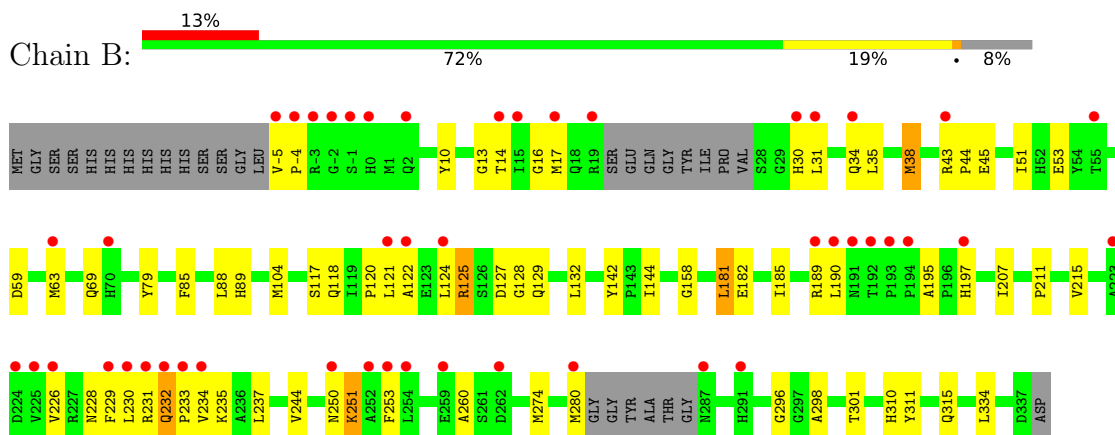

- Molecule 1: L-asparaginase 1

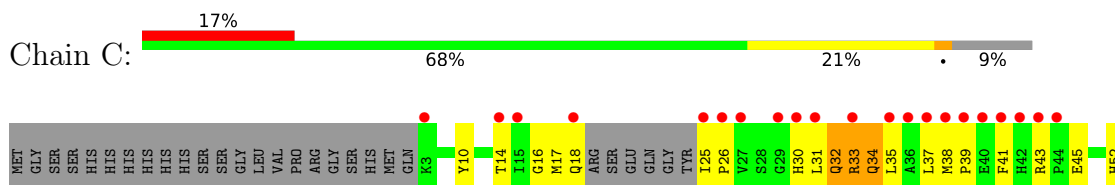

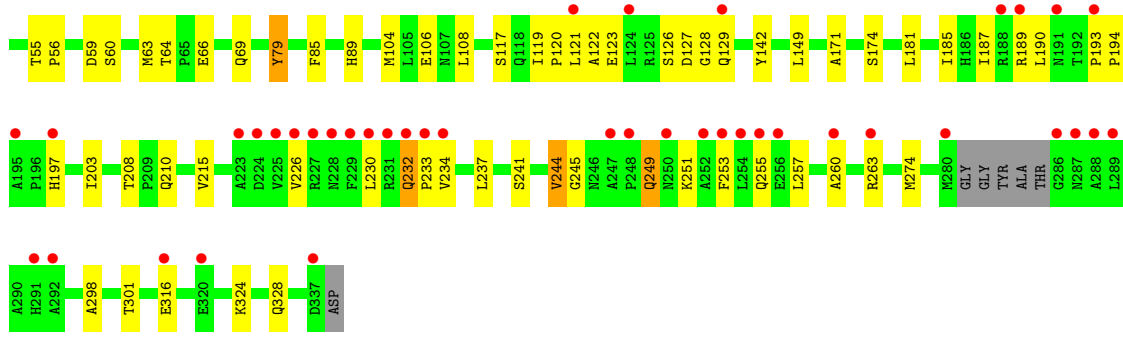

● Molecule 1: L-asparaginase 1

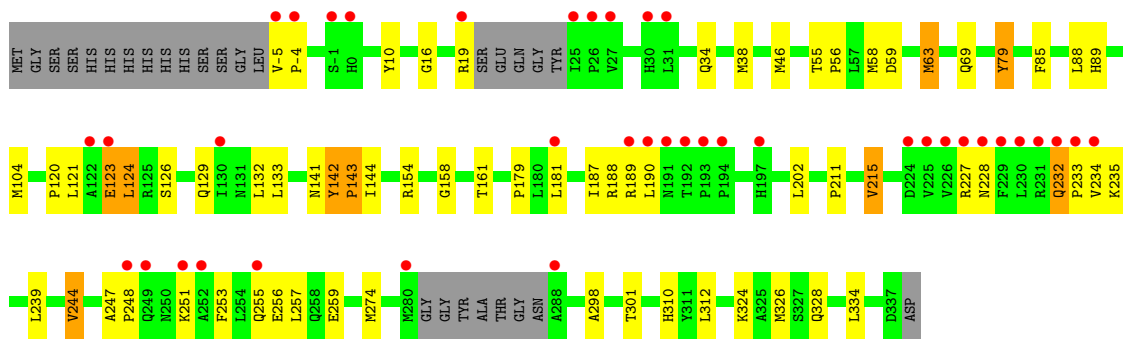
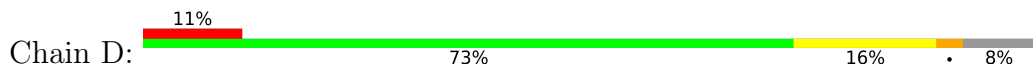

## 4 Data and refinement statistics

Property	Value	Source
Space group	P 1 21 1	Depositor
Cell constants a, b, c, $\alpha$ , $\beta$ , $\gamma$	90.52Å 89.77Å 93.29Å 90.00° 117.14° 90.00°	Depositor
Resolution (Å)	50.00 – 1.82 50.00 – 1.82	Depositor EDS
% Data completeness (in resolution range)	96.7 (50.00-1.82) 96.7 (50.00-1.82)	Depositor EDS
$R_{merge}$	(Not available)	Depositor
$R_{sym}$	0.08	Depositor
$\langle I/\sigma(I) \rangle$ <sup>1</sup>	2.38 (at 1.74Å)	Xtrriage
Refinement program	CNS 1.1	Depositor
R, $R_{free}$	0.209 , 0.226 0.207 , 0.225	Depositor DCC
$R_{free}$ test set	6685 reflections (5.05%)	wwPDB-VP
Wilson B-factor (Å <sup>2</sup> )	19.7	Xtrriage
Anisotropy	0.124	Xtrriage
Bulk solvent $k_{sol}$ (e/Å <sup>3</sup> ), $B_{sol}$ (Å <sup>2</sup> )	0.37 , 46.2	EDS
L-test for twinning <sup>2</sup>	$\langle  L  \rangle = 0.49$ , $\langle L^2 \rangle = 0.32$	Xtrriage
Estimated twinning fraction	0.015 for h,-k,-h-l	Xtrriage
$F_o, F_c$ correlation	0.94	EDS
Total number of atoms	10664	wwPDB-VP
Average B, all atoms (Å <sup>2</sup> )	26.0	wwPDB-VP

Xtrriage's analysis on translational NCS is as follows: *The largest off-origin peak in the Patterson function is 5.19% of the height of the origin peak. No significant pseudotranslation is detected.*

<sup>1</sup>Intensities estimated from amplitudes.

<sup>2</sup>Theoretical values of  $\langle |L| \rangle$ ,  $\langle L^2 \rangle$  for acentric reflections are 0.5, 0.333 respectively for untwinned datasets, and 0.375, 0.2 for perfectly twinned datasets.

## 5 Model quality [i](#)

### 5.1 Standard geometry [i](#)

Bond lengths and bond angles in the following residue types are not validated in this section: EDO

The Z score for a bond length (or angle) is the number of standard deviations the observed value is removed from the expected value. A bond length (or angle) with  $|Z| > 5$  is considered an outlier worth inspection. RMSZ is the root-mean-square of all Z scores of the bond lengths (or angles).

Mol	Chain	Bond lengths		Bond angles	
		RMSZ	# Z  >5	RMSZ	# Z  >5
1	A	0.37	0/2529	0.92	8/3443 (0.2%)
1	B	0.38	0/2574	0.93	9/3504 (0.3%)
1	C	0.37	0/2544	0.92	7/3463 (0.2%)
1	D	0.37	0/2587	0.95	9/3522 (0.3%)
All	All	0.37	0/10234	0.93	33/13932 (0.2%)

There are no bond length outliers.

The worst 5 of 33 bond angle outliers are listed below:

Mol	Chain	Res	Type	Atoms	Z	Observed(°)	Ideal(°)
1	B	235	LYS	N-CA-C	-9.05	102.64	114.31
1	D	142	TYR	CA-C-N	8.60	130.59	119.84
1	D	142	TYR	C-N-CA	8.60	130.59	119.84
1	C	59	ASP	N-CA-C	-8.28	97.11	110.20
1	B	59	ASP	N-CA-C	-7.99	97.58	110.20

There are no chirality outliers.

There are no planarity outliers.

### 5.2 Too-close contacts [i](#)

In the following table, the Non-H and H(model) columns list the number of non-hydrogen atoms and hydrogen atoms in the chain respectively. The H(added) column lists the number of hydrogen atoms added and optimized by MolProbity. The Clashes column lists the number of clashes within the asymmetric unit, whereas Symm-Clashes lists symmetry-related clashes.

Mol	Chain	Non-H	H(model)	H(added)	Clashes	Symm-Clashes
1	A	2475	0	2431	60	0
1	B	2518	0	2470	63	0

*Continued on next page...*

Continued from previous page...

Mol	Chain	Non-H	H(model)	H(added)	Clashes	Symm-Clashes
1	C	2489	0	2456	67	0
1	D	2531	0	2485	53	0
2	A	8	0	3	0	0
2	B	8	0	3	0	0
2	C	8	0	3	0	0
2	D	8	0	3	0	0
3	A	18	0	10	0	0
3	B	18	0	10	1	0
3	C	18	0	10	0	0
3	D	18	0	10	0	0
4	A	8	0	10	2	0
4	B	8	0	10	2	0
4	C	8	0	10	2	0
4	D	8	0	10	1	0
5	A	128	0	0	1	0
5	B	122	0	0	3	0
5	C	115	0	0	0	0
5	D	150	0	0	2	0
All	All	10664	0	9934	237	0

The all-atom clashscore is defined as the number of clashes found per 1000 atoms (including hydrogen atoms). The all-atom clashscore for this structure is 12.

The worst 5 of 237 close contacts within the same asymmetric unit are listed below, sorted by their clash magnitude.

Atom-1	Atom-2	Interatomic distance (Å)	Clash overlap (Å)
1:C:230:LEU:HD11	1:C:260:ALA:HA	1.44	0.99
1:D:121:LEU:HD12	1:D:129:GLN:HE21	1.31	0.93
1:B:274:MET:HE3	1:D:274:MET:HB2	1.50	0.92
1:C:32:GLN:H	1:C:32:GLN:NE2	1.72	0.87
1:C:32:GLN:H	1:C:32:GLN:HE21	1.22	0.84

There are no symmetry-related clashes.

## 5.3 Torsion angles [i](#)

### 5.3.1 Protein backbone [i](#)

In the following table, the Percentiles column shows the percent Ramachandran outliers of the chain as a percentile score with respect to all X-ray entries followed by that with respect to entries of similar resolution.

The Analysed column shows the number of residues for which the backbone conformation was analysed, and the total number of residues.

Mol	Chain	Analysed	Favoured	Allowed	Outliers	Percentiles	
1	A	318/358 (89%)	307 (96%)	10 (3%)	1 (0%)	36	26
1	B	323/358 (90%)	312 (97%)	9 (3%)	2 (1%)	21	11
1	C	318/358 (89%)	307 (96%)	9 (3%)	2 (1%)	21	11
1	D	325/358 (91%)	314 (97%)	7 (2%)	4 (1%)	10	3
All	All	1284/1432 (90%)	1240 (97%)	35 (3%)	9 (1%)	18	8

5 of 9 Ramachandran outliers are listed below:

Mol	Chain	Res	Type
1	A	232	GLN
1	B	232	GLN
1	C	232	GLN
1	D	123	GLU
1	D	232	GLN

### 5.3.2 Protein sidechains [i](#)

In the following table, the Percentiles column shows the percent sidechain outliers of the chain as a percentile score with respect to all X-ray entries followed by that with respect to entries of similar resolution.

The Analysed column shows the number of residues for which the sidechain conformation was analysed, and the total number of residues.

Mol	Chain	Analysed	Rotameric	Outliers	Percentiles	
1	A	263/297 (89%)	258 (98%)	5 (2%)	50	37
1	B	268/297 (90%)	265 (99%)	3 (1%)	65	56
1	C	267/297 (90%)	263 (98%)	4 (2%)	57	46
1	D	269/297 (91%)	265 (98%)	4 (2%)	57	46
All	All	1067/1188 (90%)	1051 (98%)	16 (2%)	57	46

5 of 16 residues with a non-rotameric sidechain are listed below:

Mol	Chain	Res	Type
1	D	202	LEU
1	D	124	LEU
1	C	32	GLN

*Continued on next page...*

*Continued from previous page...*

Mol	Chain	Res	Type
1	D	63	MET
1	B	251	LYS

Sometimes sidechains can be flipped to improve hydrogen bonding and reduce clashes. 5 of 41 such sidechains are listed below:

Mol	Chain	Res	Type
1	C	287	ASN
1	D	228	ASN
1	D	18	GLN
1	D	134	ASN
1	D	272	GLN

### 5.3.3 RNA [i](#)

There are no RNA molecules in this entry.

## 5.4 Non-standard residues in protein, DNA, RNA chains [i](#)

There are no non-standard protein/DNA/RNA residues in this entry.

## 5.5 Carbohydrates [i](#)

There are no oligosaccharides in this entry.

## 5.6 Ligand geometry [i](#)

20 ligands are modelled in this entry.

In the following table, the Counts columns list the number of bonds (or angles) for which Mogul statistics could be retrieved, the number of bonds (or angles) that are observed in the model and the number of bonds (or angles) that are defined in the Chemical Component Dictionary. The Link column lists molecule types, if any, to which the group is linked. The Z score for a bond length (or angle) is the number of standard deviations the observed value is removed from the expected value. A bond length (or angle) with  $|Z| > 2$  is considered an outlier worth inspection. RMSZ is the root-mean-square of all Z scores of the bond lengths (or angles).

Mol	Type	Chain	Res	Link	Bond lengths			Bond angles		
					Counts	RMSZ	$\# Z  > 2$	Counts	RMSZ	$\# Z  > 2$
3	ASN	B	6002[B]	-	7,8,8	1.23	1 (14%)	6,10,10	1.83	1 (16%)

Mol	Type	Chain	Res	Link	Bond lengths			Bond angles		
					Counts	RMSZ	# Z  > 2	Counts	RMSZ	# Z  > 2
2	ASP	C	7003[A]	1	6,7,8	1.47	1 (16%)	3,8,10	0.85	0
4	EDO	A	9002	-	3,3,3	2.00	1 (33%)	2,2,2	0.38	0
4	EDO	C	9001	-	3,3,3	1.99	1 (33%)	2,2,2	0.36	0
3	ASN	D	6004[B]	-	7,8,8	1.18	1 (14%)	6,10,10	1.50	1 (16%)
3	ASN	A	6001[B]	-	7,8,8	1.24	1 (14%)	6,10,10	1.88	1 (16%)
3	ASN	D	8004	-	7,8,8	1.16	1 (14%)	6,10,10	1.12	1 (16%)
4	EDO	B	9006	-	3,3,3	1.95	1 (33%)	2,2,2	0.32	0
4	EDO	D	9008	-	3,3,3	1.94	1 (33%)	2,2,2	0.29	0
3	ASN	B	8002	-	7,8,8	1.19	1 (14%)	6,10,10	1.17	1 (16%)
2	ASP	A	7001[A]	1	6,7,8	1.62	1 (16%)	3,8,10	0.98	0
4	EDO	B	9004	-	3,3,3	2.08	1 (33%)	2,2,2	0.40	0
3	ASN	C	6003[B]	-	7,8,8	1.22	1 (14%)	6,10,10	1.78	1 (16%)
3	ASN	C	8003	-	7,8,8	1.14	1 (14%)	6,10,10	1.10	1 (16%)
2	ASP	D	7004[A]	1	6,7,8	1.99	1 (16%)	3,8,10	1.01	0
2	ASP	B	7002[A]	1	6,7,8	1.83	1 (16%)	3,8,10	0.97	0
3	ASN	A	8001	-	7,8,8	1.17	1 (14%)	6,10,10	1.14	1 (16%)
4	EDO	A	9005	-	3,3,3	1.91	1 (33%)	2,2,2	0.29	0
4	EDO	C	9007	-	3,3,3	1.97	1 (33%)	2,2,2	0.32	0
4	EDO	D	9003	-	3,3,3	2.07	1 (33%)	2,2,2	0.40	0

In the following table, the Chirals column lists the number of chiral outliers, the number of chiral centers analysed, the number of these observed in the model and the number defined in the Chemical Component Dictionary. Similar counts are reported in the Torsion and Rings columns. '-' means no outliers of that kind were identified.

Mol	Type	Chain	Res	Link	Chirals	Torsions	Rings
3	ASN	B	6002[B]	-	-	1/8/8/8	-
2	ASP	C	7003[A]	1	-	3/7/7/8	-
4	EDO	A	9002	-	-	0/1/1/1	-
4	EDO	C	9001	-	-	0/1/1/1	-
3	ASN	D	6004[B]	-	-	0/8/8/8	-
3	ASN	A	6001[B]	-	-	0/8/8/8	-
3	ASN	D	8004	-	-	2/8/8/8	-
4	EDO	B	9006	-	-	0/1/1/1	-
4	EDO	D	9008	-	-	0/1/1/1	-
3	ASN	B	8002	-	-	2/8/8/8	-
2	ASP	A	7001[A]	1	-	3/7/7/8	-

Continued on next page...

Continued from previous page...

Mol	Type	Chain	Res	Link	Chirals	Torsions	Rings
4	EDO	B	9004	-	-	0/1/1/1	-
3	ASN	C	6003[B]	-	-	0/8/8/8	-
3	ASN	C	8003	-	-	2/8/8/8	-
2	ASP	D	7004[A]	1	-	3/7/7/8	-
2	ASP	B	7002[A]	1	-	3/7/7/8	-
3	ASN	A	8001	-	-	2/8/8/8	-
4	EDO	A	9005	-	-	0/1/1/1	-
4	EDO	C	9007	-	-	0/1/1/1	-
4	EDO	D	9003	-	-	0/1/1/1	-

The worst 5 of 20 bond length outliers are listed below:

Mol	Chain	Res	Type	Atoms	Z	Observed(Å)	Ideal(Å)
2	D	7004[A]	ASP	CB-CG	4.16	1.60	1.50
2	B	7002[A]	ASP	CB-CG	3.78	1.59	1.50
4	B	9004	EDO	O2-C2	-3.55	1.24	1.42
4	D	9003	EDO	O2-C2	-3.53	1.24	1.42
4	A	9002	EDO	O2-C2	-3.41	1.24	1.42

The worst 5 of 8 bond angle outliers are listed below:

Mol	Chain	Res	Type	Atoms	Z	Observed(°)	Ideal(°)
3	A	6001[B]	ASN	CA-CB-CG	4.38	121.01	112.21
3	C	6003[B]	ASN	CA-CB-CG	4.21	120.67	112.21
3	B	6002[B]	ASN	CA-CB-CG	4.20	120.66	112.21
3	D	6004[B]	ASN	CA-CB-CG	3.41	119.07	112.21
3	B	8002	ASN	CA-CB-CG	2.62	117.48	112.21

There are no chirality outliers.

5 of 21 torsion outliers are listed below:

Mol	Chain	Res	Type	Atoms
2	B	7002[A]	ASP	O-C-CA-N
2	A	7001[A]	ASP	OXT-C-CA-N
2	D	7004[A]	ASP	OXT-C-CA-N
2	B	7002[A]	ASP	OXT-C-CA-N
2	C	7003[A]	ASP	OXT-C-CA-N

There are no ring outliers.

8 monomers are involved in 8 short contacts:

Mol	Chain	Res	Type	Clashes	Symm-Clashes
3	B	6002[B]	ASN	1	0
4	A	9002	EDO	1	0
4	C	9001	EDO	1	0
4	B	9006	EDO	1	0
4	B	9004	EDO	1	0
4	A	9005	EDO	1	0
4	C	9007	EDO	1	0
4	D	9003	EDO	1	0

## 5.7 Other polymers [i](#)

There are no such residues in this entry.

## 5.8 Polymer linkage issues [i](#)

There are no chain breaks in this entry.

## 6 Fit of model and data [i](#)

### 6.1 Protein, DNA and RNA chains [i](#)

In the following table, the column labelled ‘#RSRZ > 2’ contains the number (and percentage) of RSRZ outliers, followed by percent RSRZ outliers for the chain as percentile scores relative to all X-ray entries and entries of similar resolution. The OWAB column contains the minimum, median, 95<sup>th</sup> percentile and maximum values of the occupancy-weighted average B-factor per residue. The column labelled ‘Q < 0.9’ lists the number of (and percentage) of residues with an average occupancy less than 0.9.

Mol	Chain	Analysed	<RSRZ>	#RSRZ>2	OWAB(Å <sup>2</sup> )	Q<0.9
1	A	324/358 (90%)	0.87	58 (17%) 3 4	13, 23, 49, 58	0
1	B	329/358 (91%)	0.73	47 (14%) 6 6	14, 22, 46, 57	0
1	C	324/358 (90%)	0.88	62 (19%) 3 3	13, 24, 52, 58	0
1	D	331/358 (92%)	0.62	39 (11%) 9 10	13, 21, 44, 57	0
All	All	1308/1432 (91%)	0.77	206 (15%) 5 5	13, 22, 49, 58	0

The worst 5 of 206 RSRZ outliers are listed below:

Mol	Chain	Res	Type	RSRZ
1	D	233	PRO	13.8
1	A	233	PRO	12.2
1	B	233	PRO	11.2
1	C	233	PRO	8.2
1	C	39	PRO	7.3

### 6.2 Non-standard residues in protein, DNA, RNA chains [i](#)

There are no non-standard protein/DNA/RNA residues in this entry.

### 6.3 Carbohydrates [i](#)

There are no oligosaccharides in this entry.

### 6.4 Ligands [i](#)

In the following table, the Atoms column lists the number of modelled atoms in the group and the number defined in the chemical component dictionary. The B-factors column lists the minimum, median, 95<sup>th</sup> percentile and maximum values of B factors of atoms in the group. The column labelled ‘Q < 0.9’ lists the number of atoms with occupancy less than 0.9.

Mol	Type	Chain	Res	Atoms	RSCC	RSR	B-factors( $\text{\AA}^2$ )	Q<0.9
2	ASP	B	7002[A]	8/9	0.65	0.18	14,25,26,27	8
2	ASP	D	7004[A]	8/9	0.70	0.16	8,19,20,22	8
3	ASN	A	6001[B]	9/9	0.70	0.18	14,17,18,20	9
2	ASP	A	7001[A]	8/9	0.73	0.18	8,23,24,24	8
3	ASN	C	6003[B]	9/9	0.75	0.17	14,16,18,19	9
3	ASN	D	6004[B]	9/9	0.78	0.16	12,16,17,18	9
2	ASP	C	7003[A]	8/9	0.79	0.16	8,20,21,22	8
3	ASN	B	6002[B]	9/9	0.79	0.17	20,22,24,24	9
3	ASN	C	8003	9/9	0.86	0.12	19,21,23,26	0
4	EDO	B	9006	4/4	0.87	0.14	28,28,31,31	0
3	ASN	A	8001	9/9	0.88	0.11	17,21,23,25	0
4	EDO	C	9007	4/4	0.89	0.13	23,27,28,28	0
3	ASN	D	8004	9/9	0.90	0.10	19,20,23,23	0
4	EDO	B	9004	4/4	0.90	0.12	25,25,26,28	0
4	EDO	A	9005	4/4	0.91	0.12	22,23,26,27	0
3	ASN	B	8002	9/9	0.92	0.09	17,22,24,26	0
4	EDO	D	9008	4/4	0.92	0.10	22,24,25,27	0
4	EDO	A	9002	4/4	0.93	0.07	21,23,24,25	0
4	EDO	D	9003	4/4	0.95	0.10	25,25,26,26	0
4	EDO	C	9001	4/4	0.97	0.05	20,20,22,24	0

## 6.5 Other polymers [\(i\)](#)

There are no such residues in this entry.